

DOING THINGS WITH SOUNDS

Mark
Hancock





HOW NOW, BROWN COW?

A course in the pronunciation of English

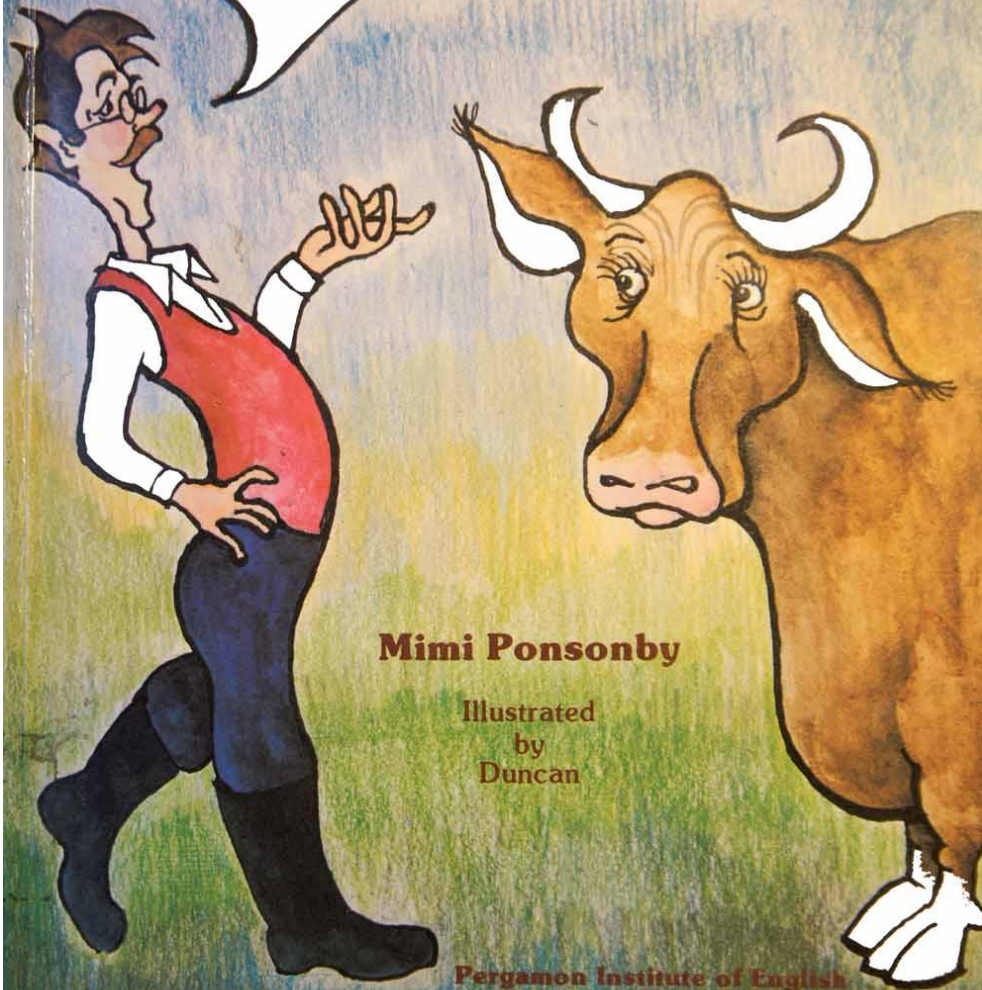

Mimi Ponsonby

Illustrated
by
Duncan

Pergamon Institute of English





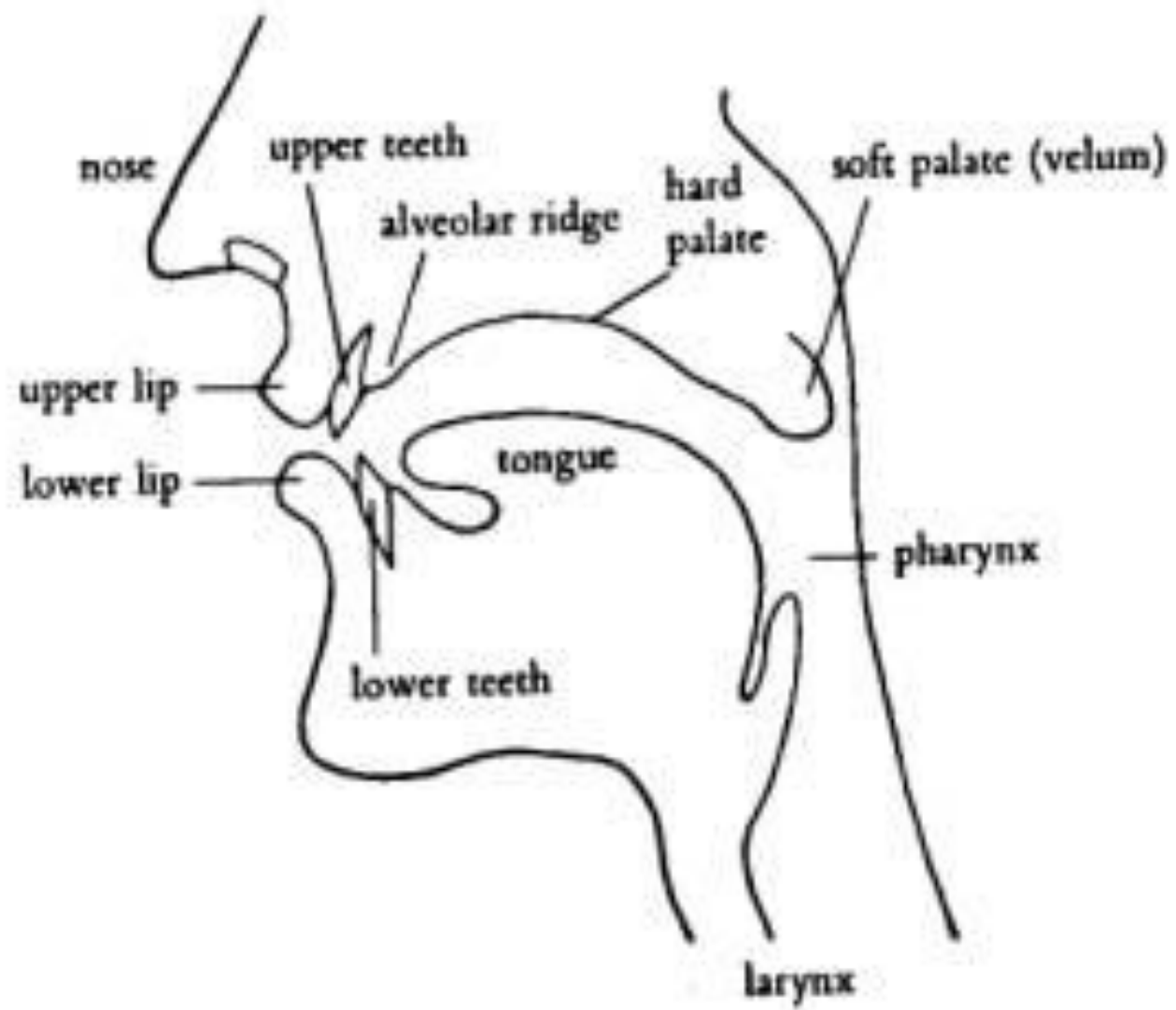



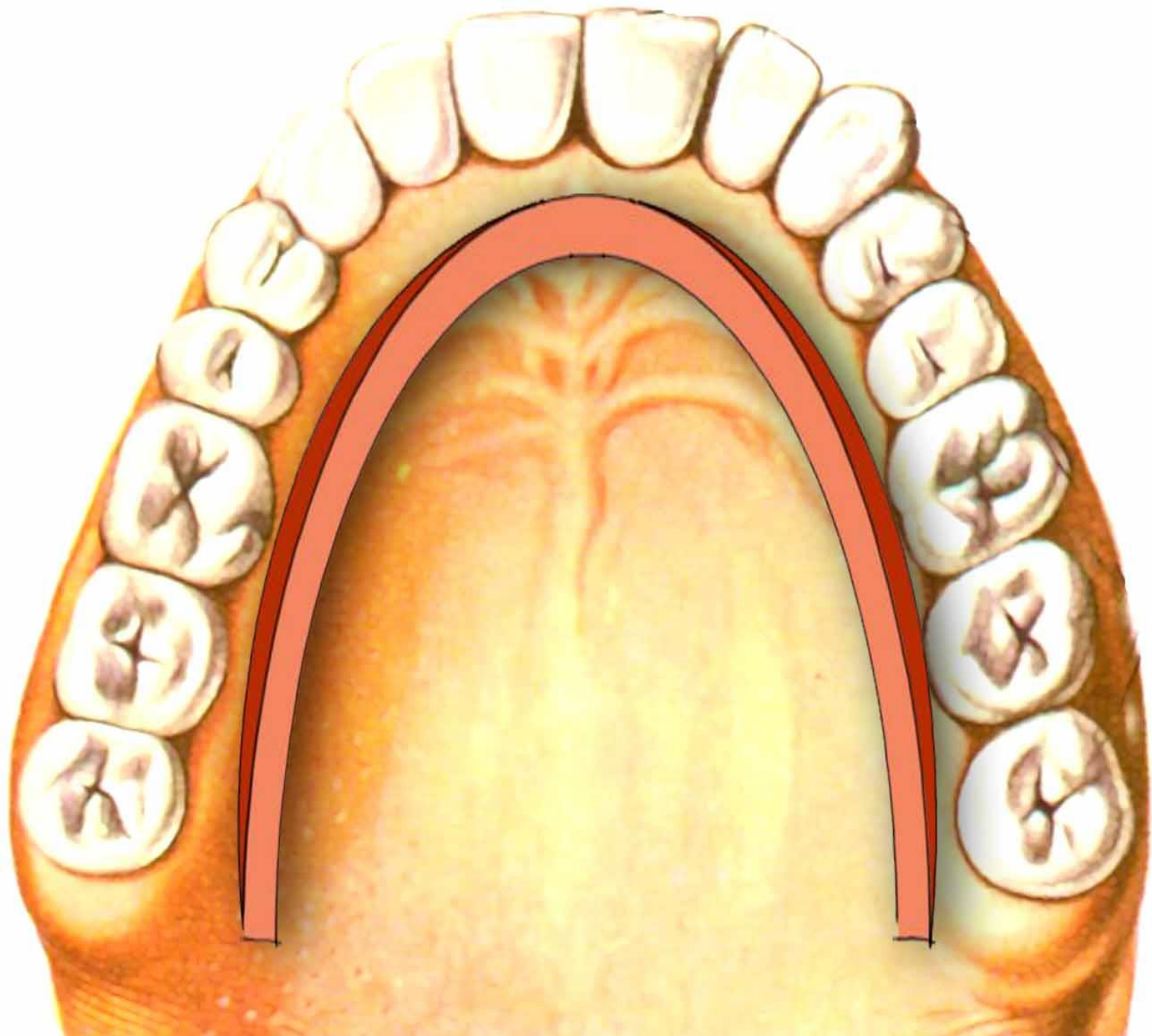

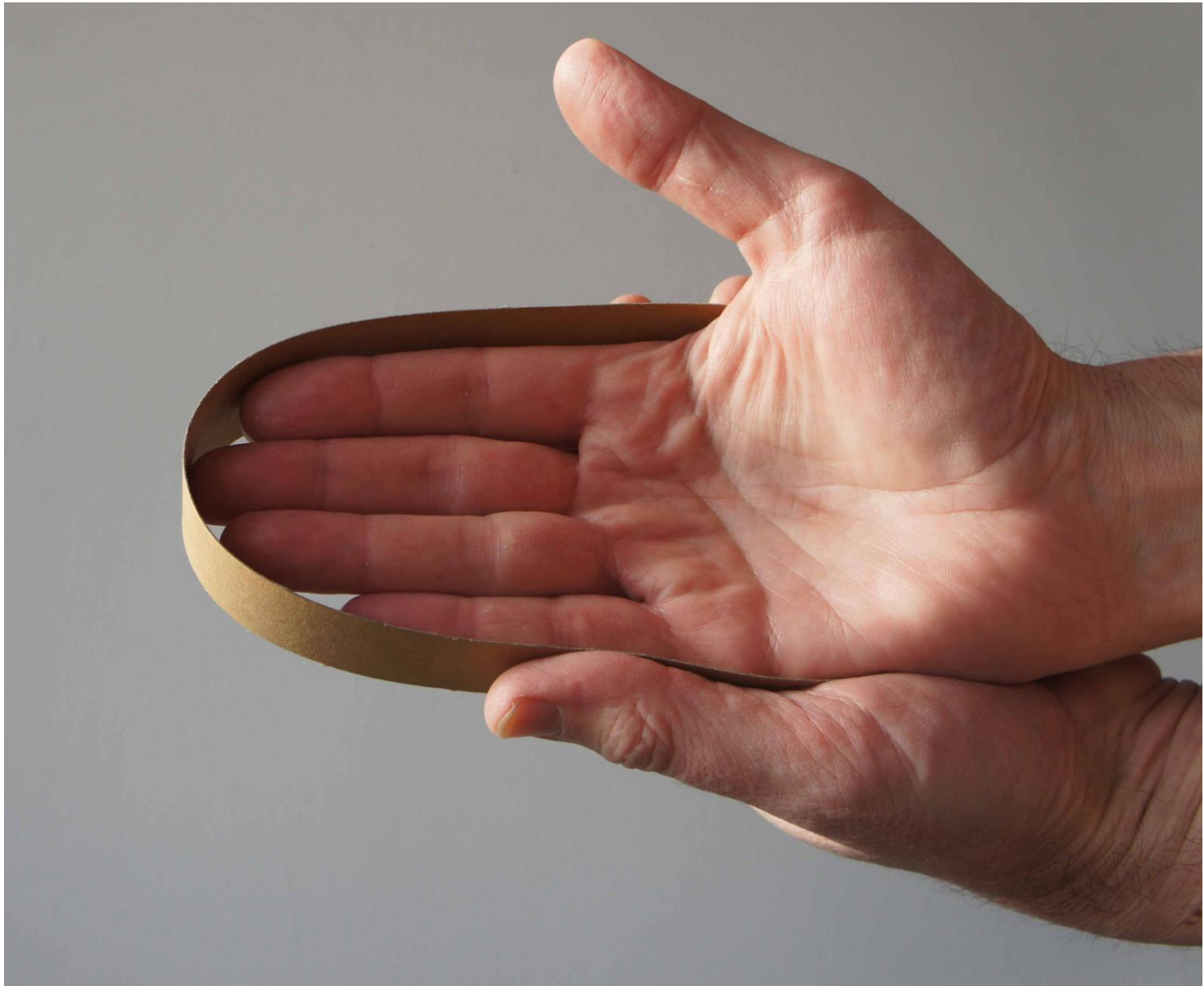

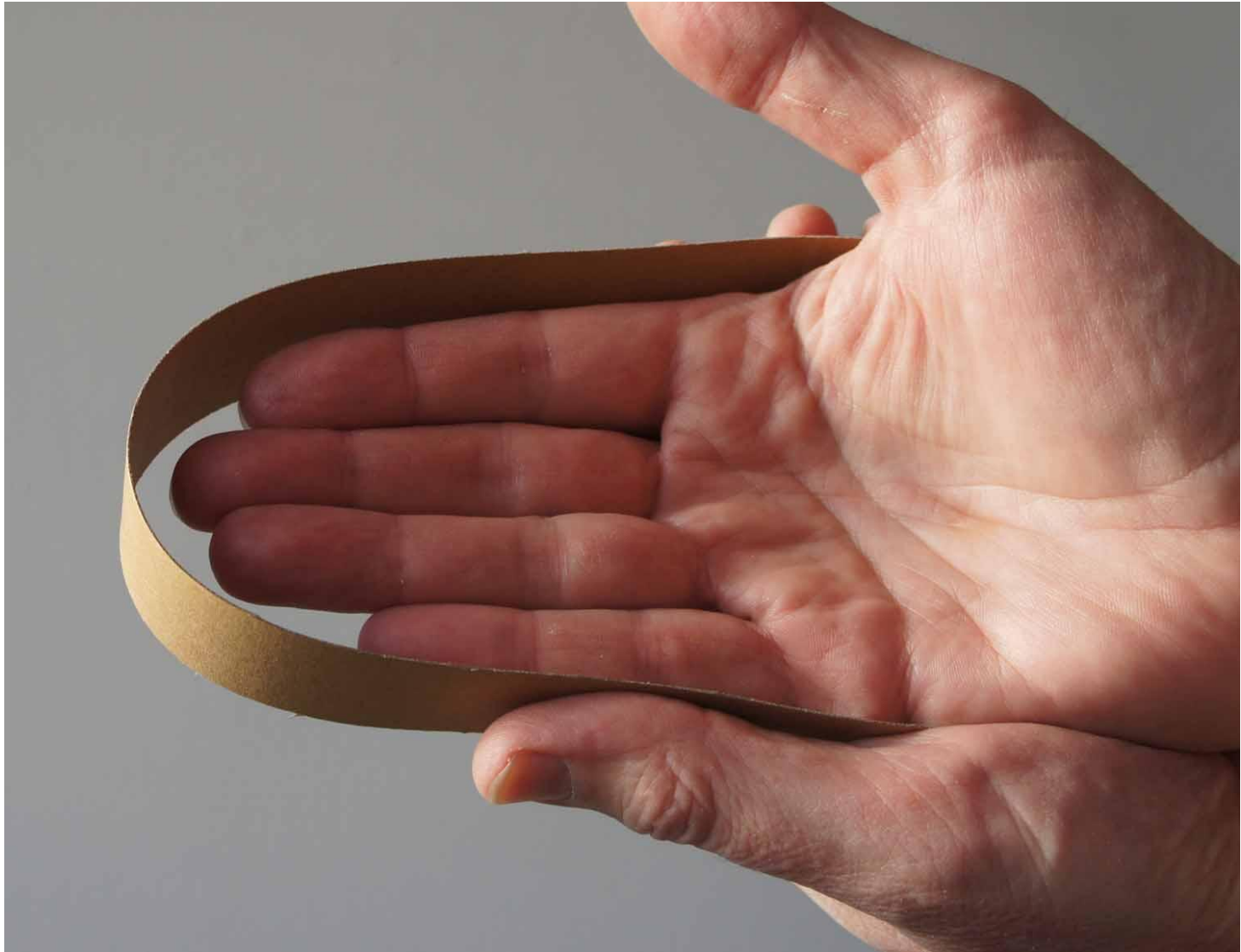



TONGUE CATS

iː



uː



eə



ʒː

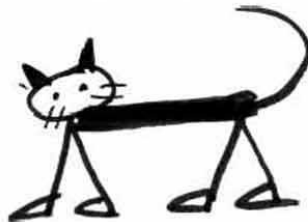

ɔː



ɑː



VOWELS

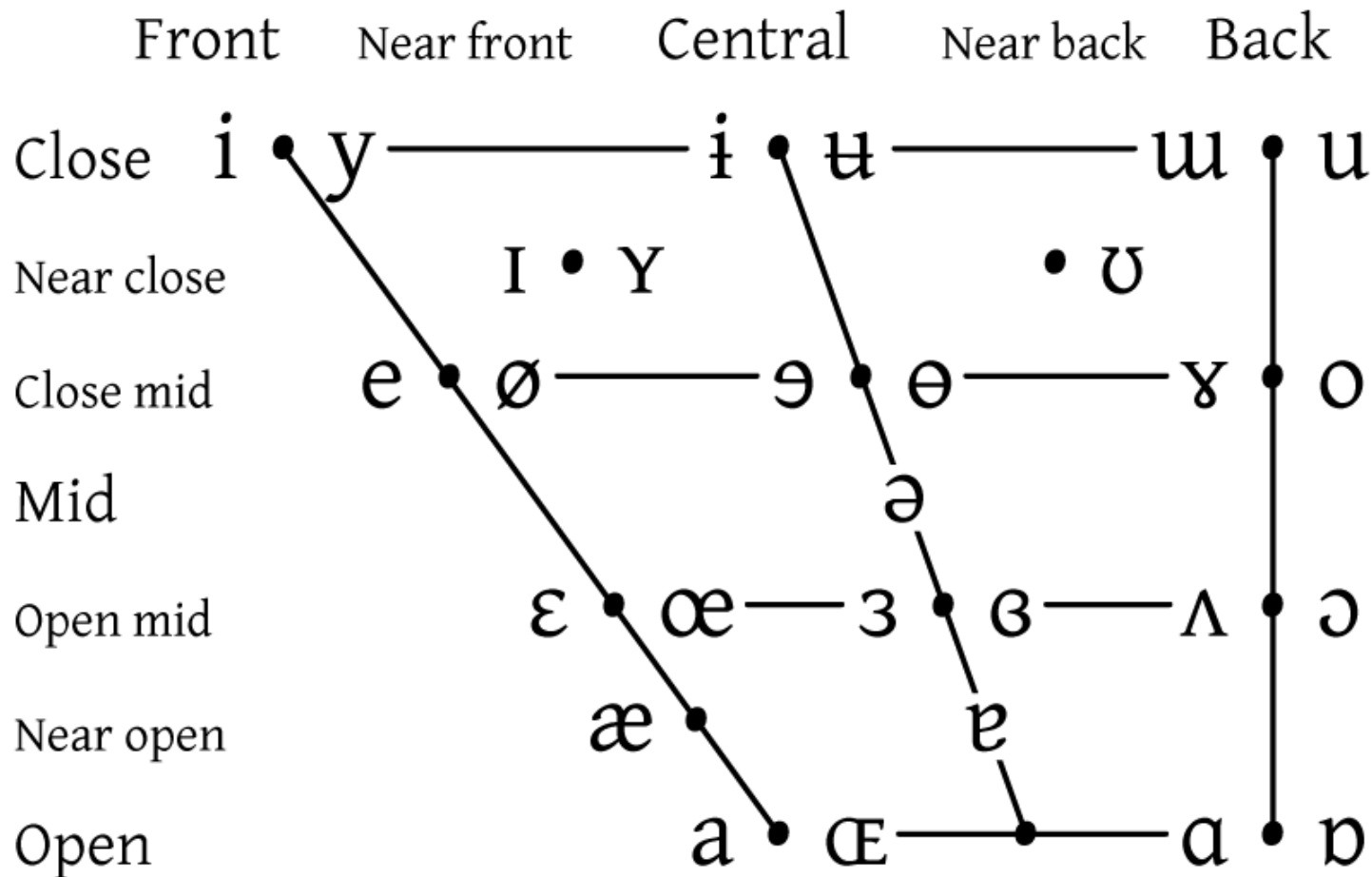

Vowels at right & left of bullets are rounded & unrounded.

ɪ	I	ʊ	u:	Iə	eɪ	ɪ	X
e	ə	ɜ:	ɔ:	ʊə	ɔɪ	əʊ	
æ	ʌ	ɑ:	ɒ	eə	aɪ	aʊ	
p	b	t	d	tʃ	dʒ	k	g
f	v	θ	ð	s	z	ʃ	ʒ
m	n	ŋ	h	l	r	w	j

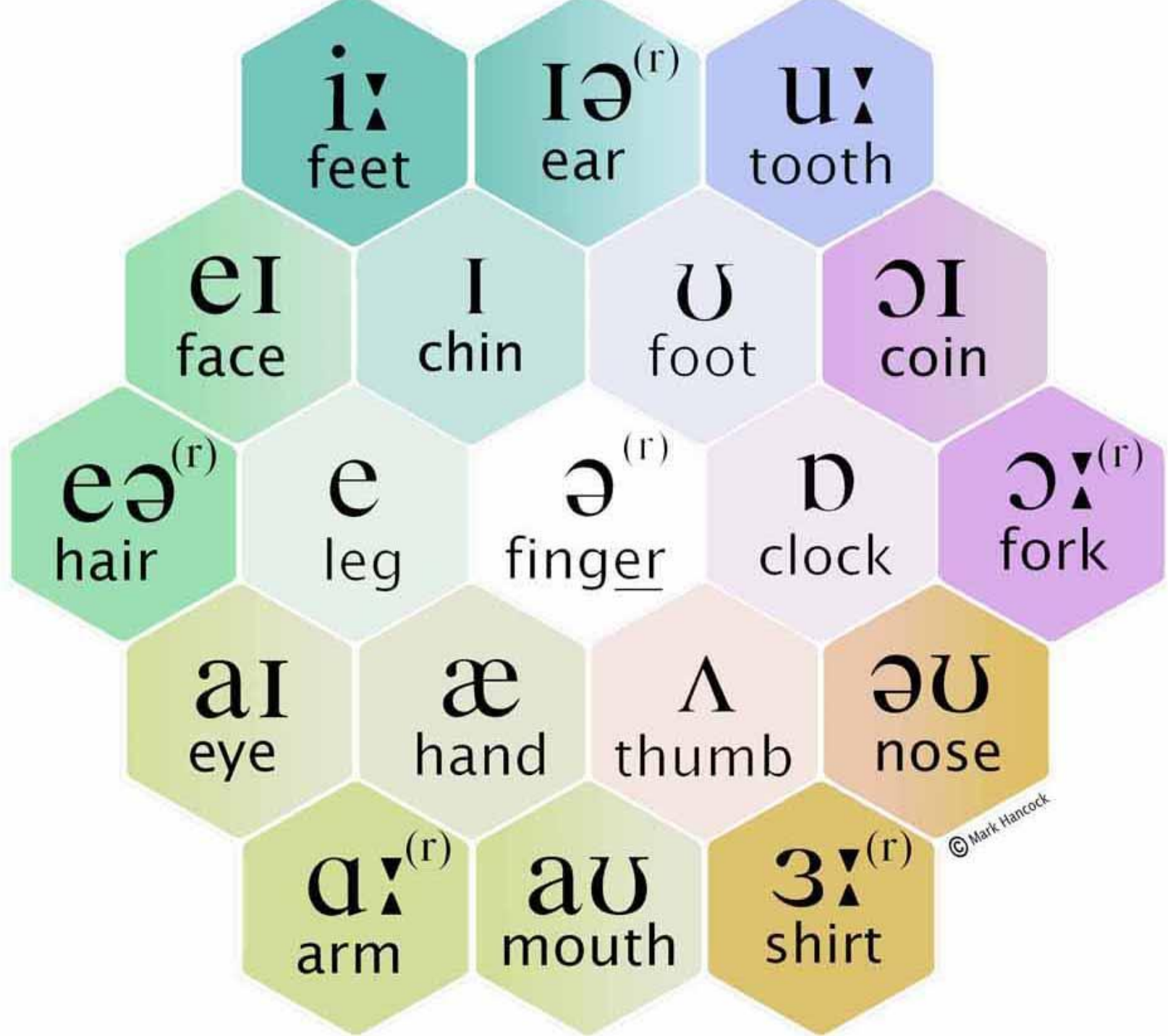

© Mark Hancock

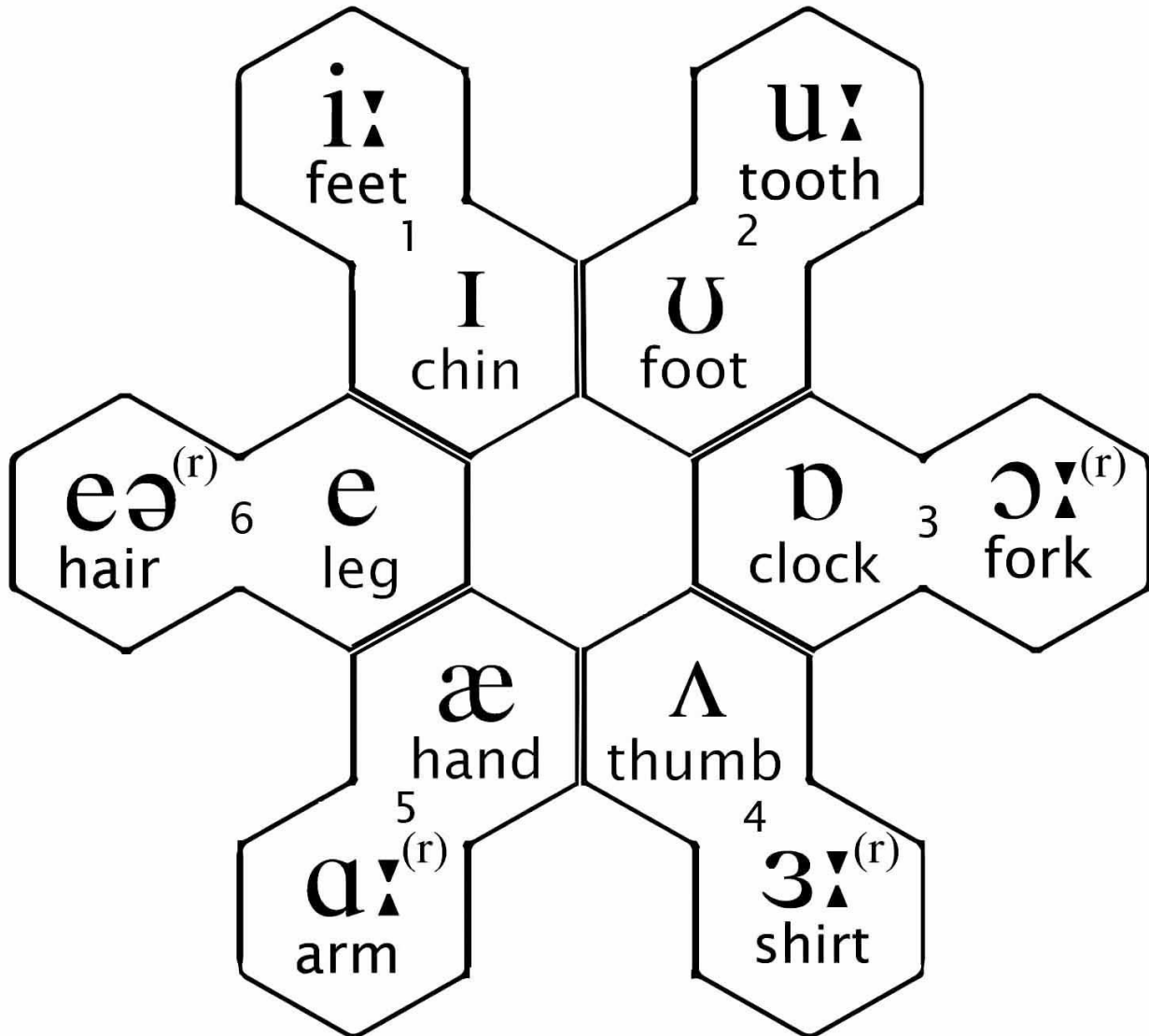

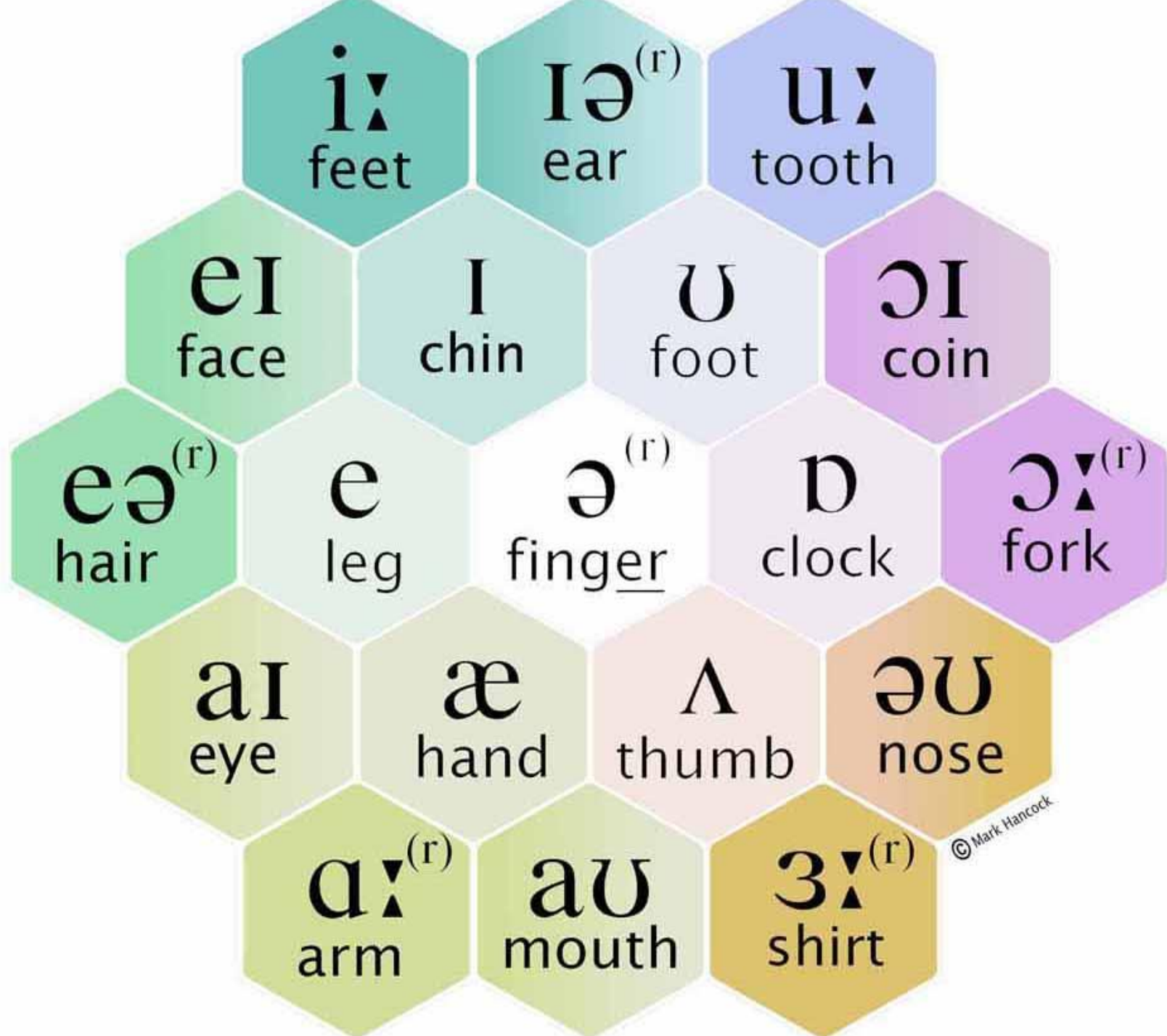

1

i feet



2

u tooth



6

eə^(r) hair



3

ɔ^(r) fork



5

ɑ^(r) arm



4

ʒ^(r) shirt

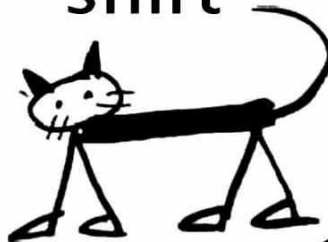

1	iː	2	uː	3	ɔː	4	ʒː	5	ɑː	6	eə
bee				bore				bar		bear	
key								car		care	
fee				four	fur			far		fair	
ski				score				scar		scare	
				store	stir			star		stair	
	drew			draw							
tree	true										
she	shoe			sure						share	
we				war	were					where	
	do			door						dare	
	cool			call	curl						
keys				cause				cars		cares	
	who'd				heard			hard		-haired	

5

Barber Shop **BRITISH HAIRWAYS** Walk in Service
Tel: 236 6922

FAST TAN SUNBEDS AVAILABLE HERE.



6

PRINTS CHARMING



7

FISH & CHIPS
FRIED CHICKEN
OPEN

The Godfather 020



8



**SOFA
SO GOOD**



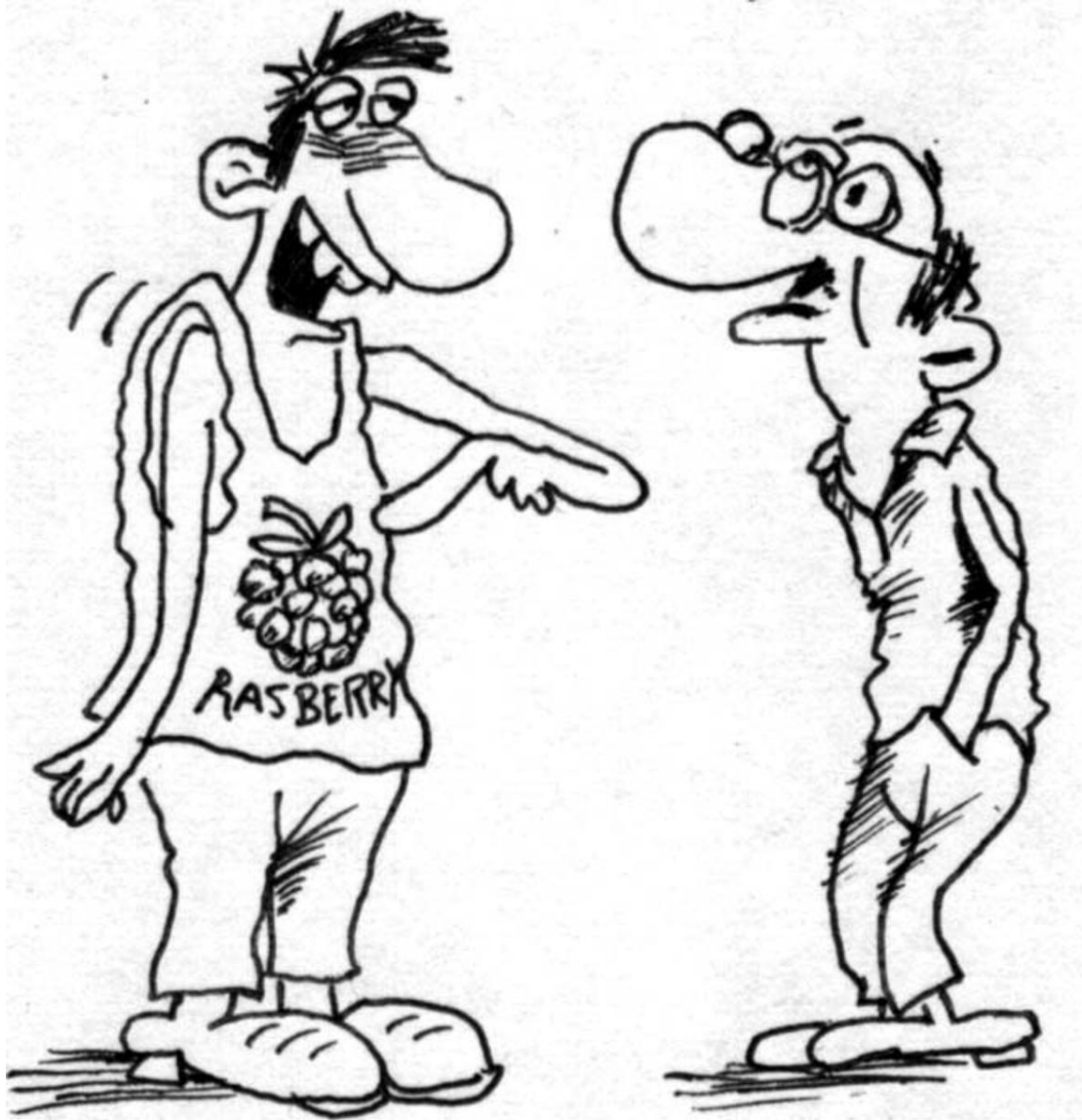

*This is my very best
berry vest!*

HANNAH'S HORSE

When Hannah's husband bought a horse
Hannah didn't mind
When Hannah's husband ran away
He left his horse behind

Now the horse is Hannah's friend
She keeps him in the house
Hannah says quite honestly
He's better than a spouse

Hanna hates to leave that horse
For more than half a day
She hurries home with happy heart
To feed him honey and hay

How Hannah loves to ride that horse
And stroke its hairy head
How hard it is to say goodnight
And head upstairs to bed

If Hannah's husband calls one day
Hoping for divorce
Happily she'll say ok
If she can have the horse

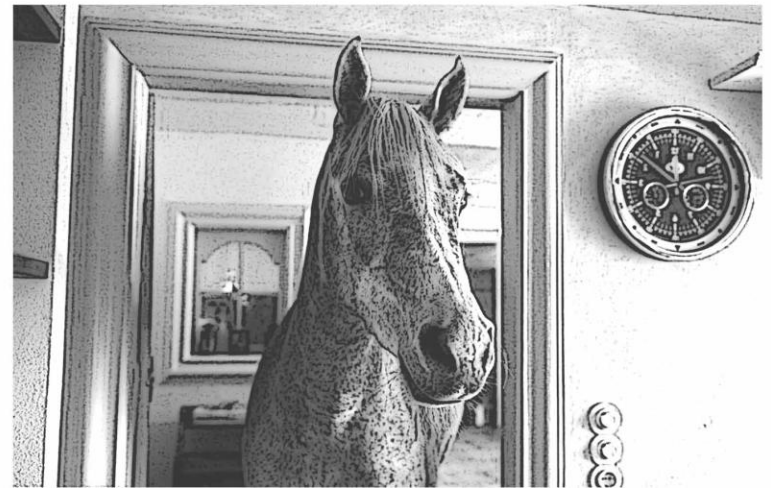

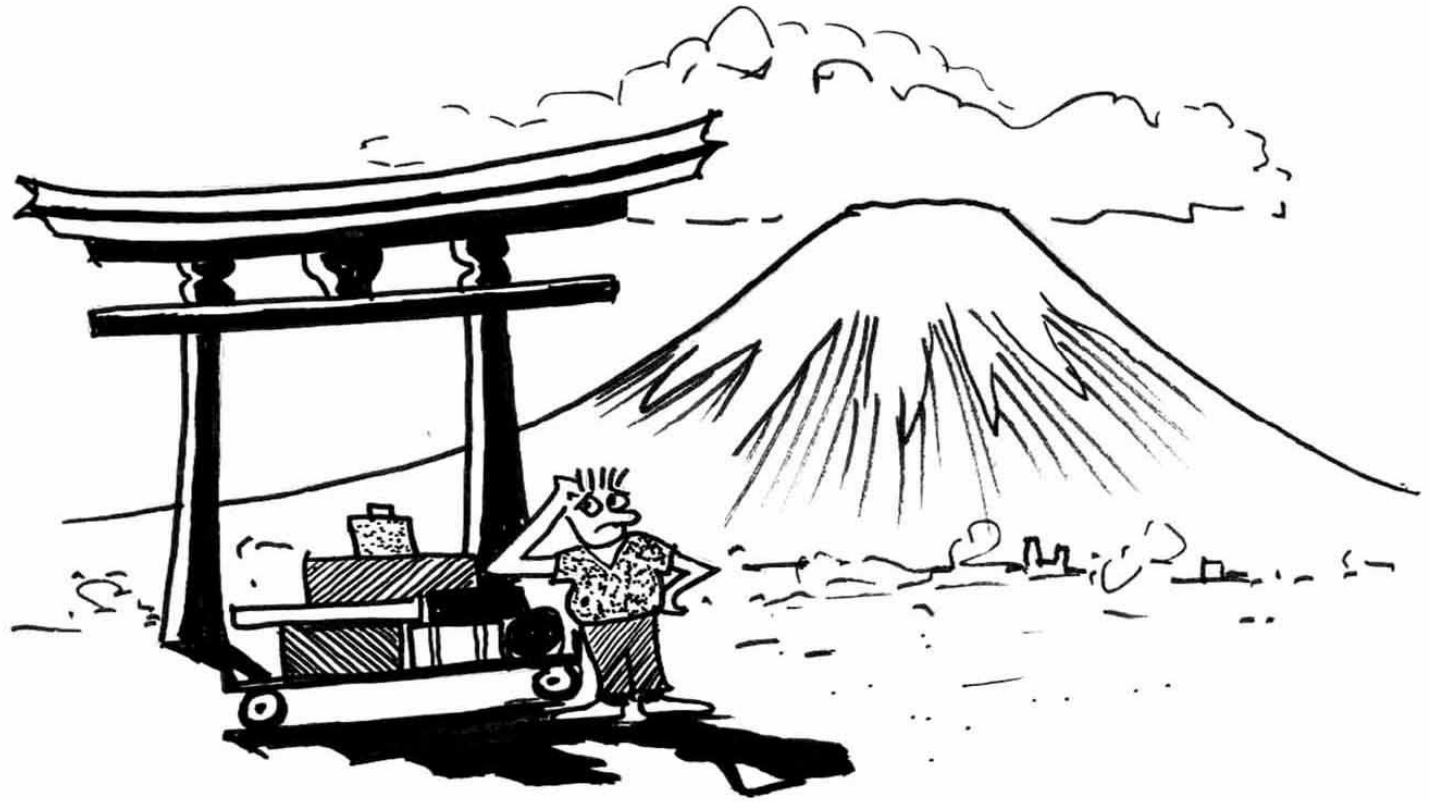

ə film crew wəs off tə Milan
Bət nothing wəs going tə plan
The cinəmətogrəphə^(r)
(Not ə great geogrəphə^(r))
Got on ə plane tə Jəpan

A

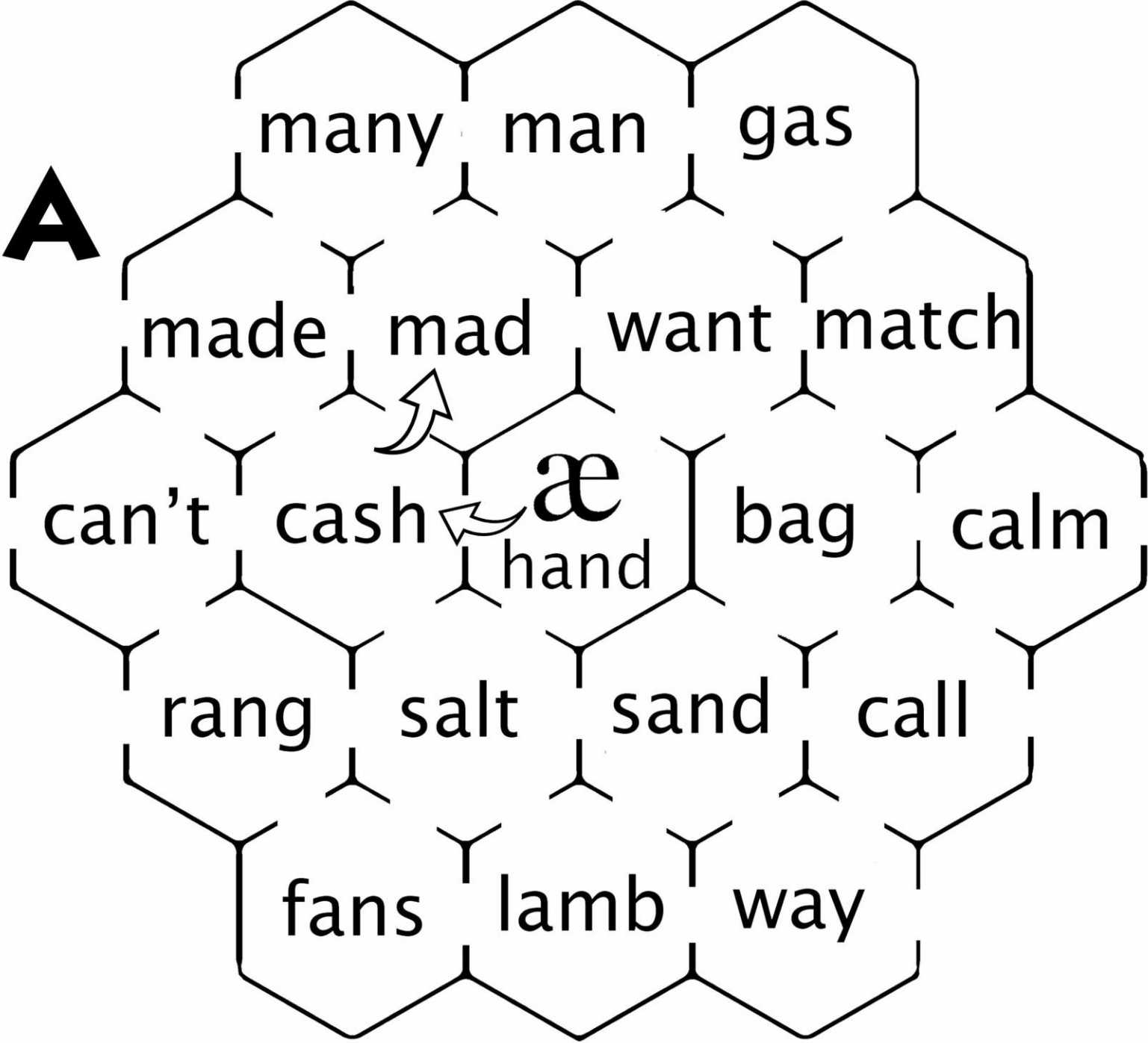



A. Washing ships



B. Watching ships



C. Washing chips



D. Watching chips

A

Students
sleep

B

A student
asleep

C

A student
sleeps

D

Students
asleep

/I/ /i/

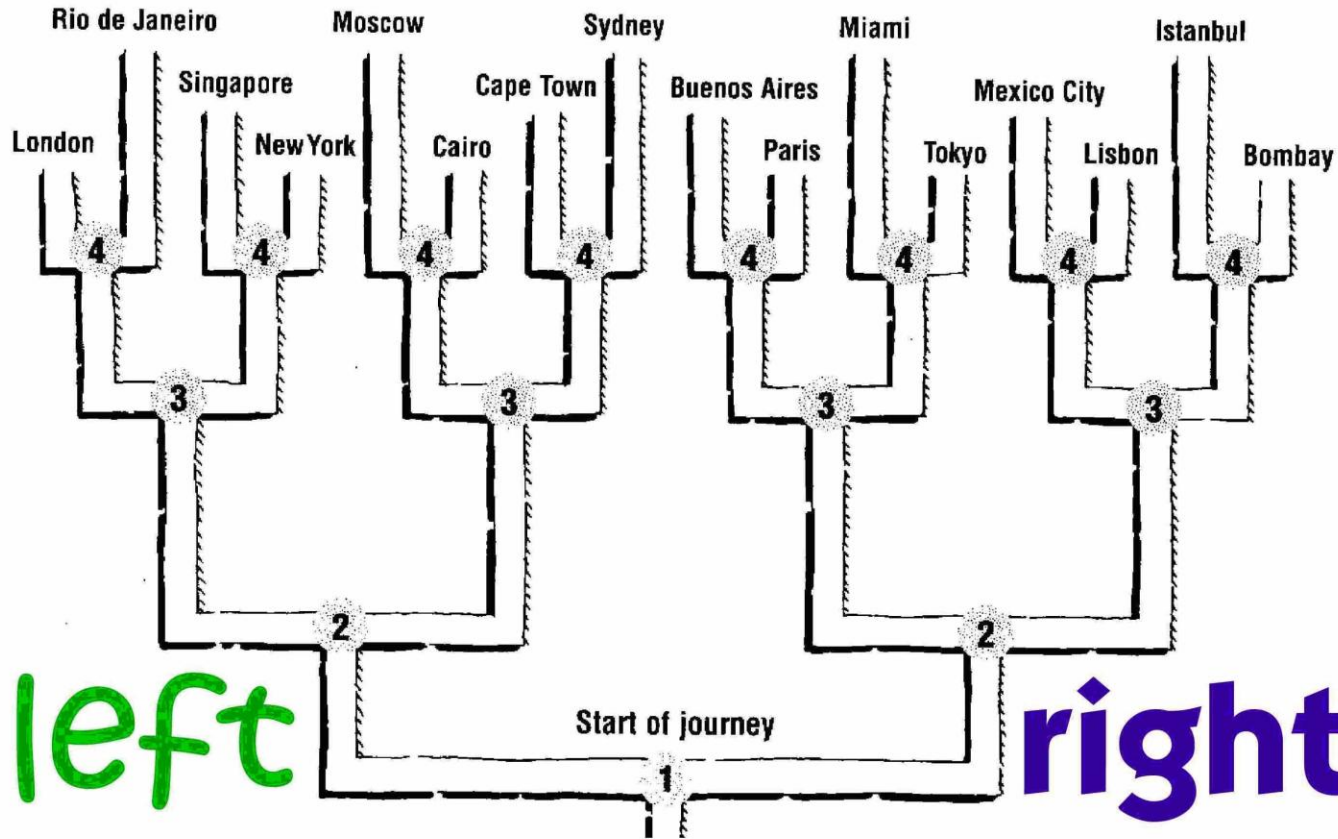

We felt the sun **hit** - **heat** our faces.

Emma didn't want to **live** - **leave** alone.

After seeing the dentist, I couldn't **fill** - **feel** my mouth.

I hate **chip** - **cheap** sandwiches.

B OR V STREET?



Grave Street



Street



Street



Street

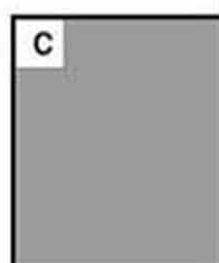

Bilton

Street

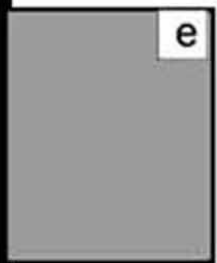

Grave



Ribber

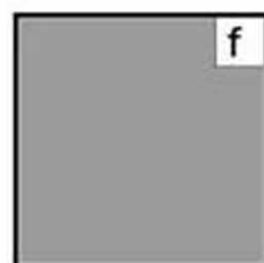

River



Vilton

Street



DOING THINGS WITH SOUNDS

Mark
Hancock

